



Luxury at Water Level



DAME CATEGORY
WINNER

The DAME - Design Award is the most significant marine equipment competition of its kind, anywhere in the world. For 28 years, it has focused attention on the art and science of design in all aspects, from styling, functionality and innovation, through to ease of implementation, practicality of use – and even packaging. It is judged by a panel of top naval architects, boat, interior and industrial designers, plus user experts. To be nominated and then to win a DAME Category and attain the ultimate prize of DAME Award Overall Winner marks a product as being at the pinnacle of design practice in the industry.

Due to design changes and improvements, the Platforms present in the pictures may not exactly depict the product purchased by the consumer.

NautiBuoy

Designed by yachtsmen, for yachtsmen

After 4 years of research, prototyping, refining, compliance and wavepool testing, NautiBuoy proudly present their elite range of multi-functional platforms and accessories.

Available in four different sizes, the NautiBuoy Marine Platform is stable, simple to manoeuvre and easy to lift from the water. These are the essential features but we didn't stop there. From stainless steel D-rings to soft handles that don't scratch the boat or mark the deck, we've thought it all through.

One of the key features is our unique Air Toggle System, which as well as allowing platforms to be linked in multiple configurations*, provide a 2nd air chamber for safety.

Our platforms are handmade to the highest standard. There's been no compromise on quality – we've obsessed over every minute detail to bring you a product that will exceed your expectations.



Contents

Leisure	6
Leisure Accessories	17
Stability	23
Extra space	24
C-Dock	28
Sport Series	30
Voyager Series	32
Jet-ski dock	34
Air Toggles	36
Choosing your platform	38
Popular configurations	42
Specifications & Sizes	44
Surface	46
Accessories	48
Maintenance use	52
Design Details	62



Leisure use

Unparalleled luxury at water level.

Page 6



Jet-ski dock

A safe & secure jet-ski dock

Page 34



C-Dock

A brilliantly simple Seabob dock.

Page 28



Maintenance use

A tender free solution.

Page 52



Choosing your platform

A simple three step process, just choose your Platform Series, Size and Surface.

Page 38



Compare

Compare the Platform series.

Page 40



Specs

All sizes, weights and inflation times.

Page 44

Leisure



Floating comfort

Relax at Water level

Unparalleled luxury at water level. A unique place to share and enjoy the finer things in life whilst relaxing in comfort on one of our platforms.

Offering freedom from the confines of the yacht, a new space that's perfect for sunbathing, finding that moment of peace, or enjoying a blissful sunset.

Your own private island

Perfect serenity

Add a new perspective to your yachting experience by taking the comforts of the yacht even closer to the shore. With the NautiBuoy Marine Platform streamed off the back of the yacht or anchored off the beach, you can choose exactly where you want to be and create perfect serenity.



“Relaxing at water level is not possible onboard, so it adds another dimension to our guests’ charter experience. They now have the ability to swim to their own small island with its own boarding ladder, float around in peace in the shallow water, and enjoy the sun whilst dangling their legs in the water in silence”.

T. Endersby, MY Heavenly Daze

Fun & safe watersports

Made even easier

A great place to have fun in the water with friends and family. You and your guests can enjoy a multitude of sports and activities, easily swapping from one to another. Not only does it provide you with a fantastic swim platform, but also an ideal area for sunbathing and relaxing.

Covered with a non-skid soft surface and made incredibly stable by a unique ballast system, the NautiBuoy Platform offers a safe spot for activities on the water.

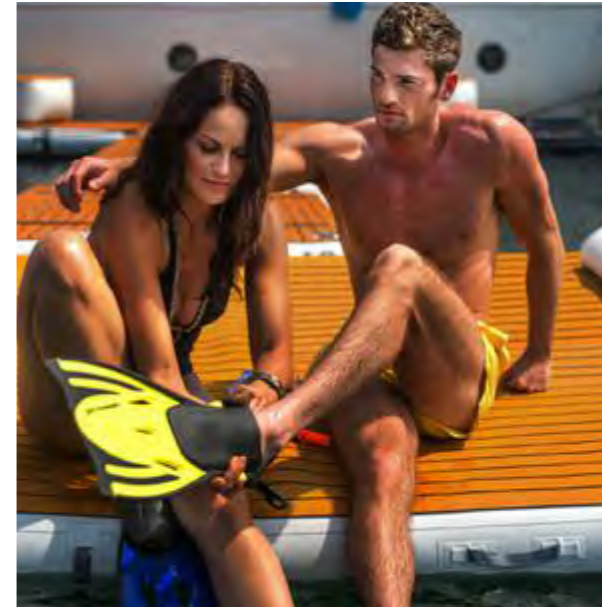



“On board Mischief we have had 4 of the NautiBuoy Platforms and other accessories for over 3 years now and they are brilliant. We use them for everything, swimming, sun bathing, launching the water toys, cleaning the sides of the boat and in particular the safety they provide when docking the tenders and unloading passengers, has proven invaluable, the NautiBuoy platforms act as an extension of our yacht that we use everyday, they are a must have item for any boat big or small. You won't find better”.

Owner : M/Y Mischief 54m



Yoga & fitness

A different dimension

Discover an alternative place of freedom to enhance your fitness and meditation practice. With no disruptions, you can focus solely on your physical well-being and mental state of clarity. Enjoy the freshness of the breeze, the warmth of the sun and the calming movement of the ocean. Create a new space that's just for you.





Leisure Accessories

Floating comfort

Accessorise for extra enjoyment

Relaxing so close to the water is one of life's most enjoyable pleasures. You can enhance your sunbathing and relaxation by adding that extra layer of comfort and luxury to your platform.

Leisure packages enable you to adapt the platform. There's also a 4-step ladder that makes getting out of the water a breeze.

Classic or luxury

What ever your preference

Take your pick from two superb leisure packs – the Classic or the Luxury Leisure Package.

Both packs include two portable comfort seats, two fastening belts and two luxury headrests. The difference is in the size of the seats.



Comfort seats

Relax

The comfort seat combines quality, beauty and comfort with innovative design. Whether you prefer to relax on the platform, the boat or the beach, the comfort seat makes an ideal spot to unwind.

Made from high quality Sunbrella® fabric specially designed for outdoor use, the comfort seats are hinged to provide both back and leg support. They have no hard exterior parts and come with the added benefit of stowing completely flat.

You don't have to worry about the seats going overboard. The fastening belt secures the seats to the platform in one easy step. They've been designed for easy removal so you can use the seats wherever you choose.



The Classic Comfort Seat features in the images throughout.



Classic Comfort Seat (smaller of the two)
Size: 145cm x 48cm x 8cm / 4'9" x 1'7" x 3"

Luxury Comfort Seat (larger of the two)
Size: 195cm x 58cm x 10cm / 6'5" x 1'11" x 4"



Luxury headrests

Enjoy

Sunbathing is made even more pleasurable with the two luxury headrests.

Like bringing your bed pillow to the platform, the headrests provide a snug but firm support whilst you stretch out, relax and enjoy a cool calm moment.

A marine grade solution made from faux leather and a quick dry foam filling, they're designed to be easily attached to the platform. They're also the ideal accessory to wrap in a towel and take to the beach.



Securing your accessories

Velcro fastening

All the platforms come as standard, with two soft Velcro strips strategically located on the top surface. The comfort seats and headrests sit firmly on the strips and have been tested for their secure fastening in a University Wave Lab. There's no fear of losing them to the sea when the wind or swell picks up.

See the wave tank in action at nautibuoymarine.com.

Climb on board

Gracefully exit the water

The user-friendly 4-step ladder makes it safe and simple for you to get back on to the platform.

The ladder locks securely and easily into place using the Multipurpose Platform Mountings (MPM's) positioned at one end of the platform. Further support is provided by the Air Toggle loops that fit snugly under the adapted ladder arms, enabling the ladder to carry up to 100kgs (220lbs).

With the frame fabricated from marine grade 316 stainless steel and with four smooth contour plastic steps, the ladder is a must have accessory for any keen swimmer.

Due to design changes and improvements, the ladder present in the picture may not exactly depict the product purchased by the consumer.





Stability

What makes it so stable

Our unique patent pending ballast system provides incredible stability to the platforms when they're on the water. Filling up quickly the four ballast bags, positioned in each corner, provide you with a stable surface almost instantly. It couldn't be easier to remove the platforms after use. The manual dump system has been carefully designed to expel the water rapidly and for you to effortlessly remove them from the water.

Extra space without the expensive refit

The simple upgrade

The NautiBuoy platforms are an easy way to extend your yacht, regardless of your vessel size or type.

“I’m a boat owner and I would love another meter or so which leaves me with a few options. Buy a bigger boat, but that would mean a bigger berth or, extend my transom with or without hydraulic rams. Either way its a quick €20,000.00.”

I want bigger because as boaters know, we all find we have more friends than we thought we had, when then sun comes out and the seas warm up.

It’s nearly 8 square meters of entertaining space and for the whole of summer it was full of ladies or children. It was a serious bit of boating brilliance that added huge dollops of space and fun at a third of the cost of any other option.”

Phillip J Ashworth, 40ft Atlantis Owner

(675 Platform)

Platform type = Extra space gained	Weight out of bag	Stowage sizes
375	3.75 m ² (40 ft ²)	22kg (48lbs) 160cm x 30cm x 30cm (5'3" x 1' x 1')
525	5.25 m ² (56 ft ²)	29.5kg (65lbs) 160cm x 33cm x 33cm (5'3" x 1'1" x 1'1")
675	6.75 m ² (72 ft ²)	33.5kg (73lbs) 165cm x 38cm x 38cm (5'5" x 1'3" x 1'3")
800	8 m ² (86 ft ²)	39.5kg (87lbs) 220cm x 32cm x 32cm (7'3" x 1'11" x 1'11")

All dimensions, weights and times indicated have a tolerance of plus or minus 5%.
All weights and dimensions indicate Sport Series Platforms.

Extra Space

How much extra space can I get?

If you're not sure what's right for you, NautiBuoy's team of experts can help you work out the perfect configuration for your yacht.



Inflated & launched
in less than five
minutes

SPORT

375

Extra space - 3.75 m² / 40 ft²

Configuration - Solo streaming

Vessel type - SY Bavaria 46

Vessel length - 14.02m / 46'

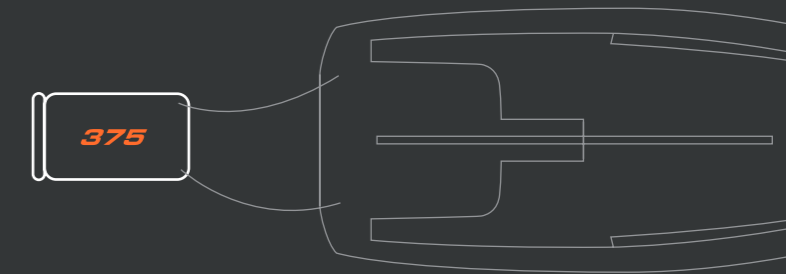

SPORT

675

Extra space - 6.75 m² / 72 ft²

Configuration - Solo

Vessel type - MY Atlantis 39 open

Vessel length - 11.8m / 39'

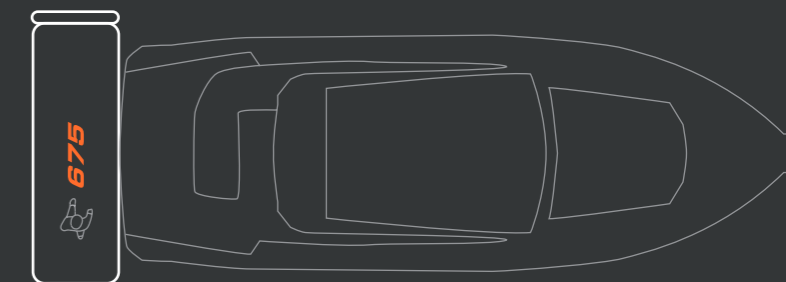

VOYAGER

675 + 525

Extra space - 12 m² / 129 ft²

Configuration - Jet-ski dock

Vessel type - MY 40m

Vessel length - 40m / 131'2"

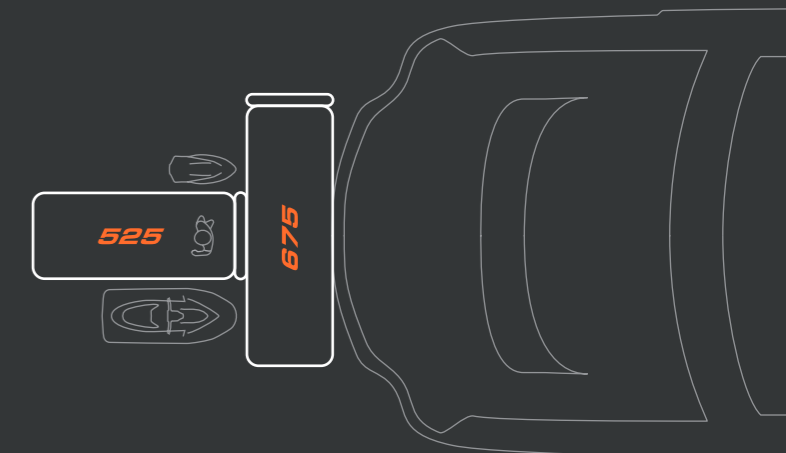

VOYAGER

800 + 675 + 800

Extra space - 22.75 m² / 245 ft²

Configuration -

Jet-ski dock + Watersports station

Vessel type - MY 50m

Vessel length - 50m / 164'

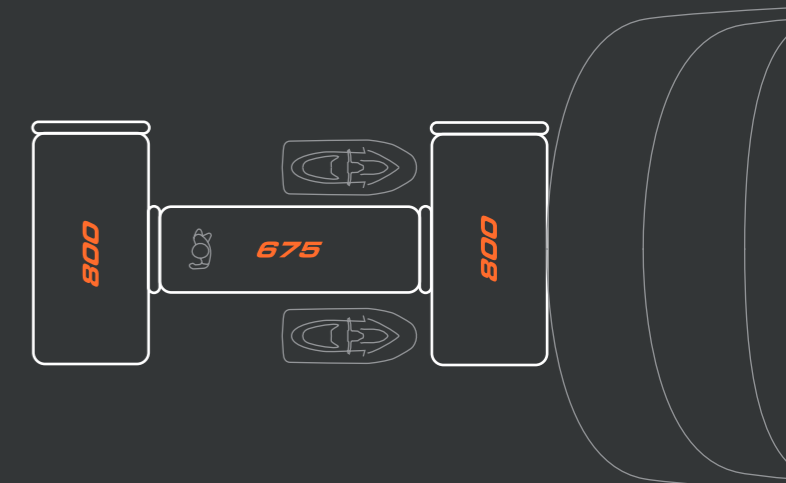



“NautiBuoy platforms are truly amazing. I have been able to create an additional 80-foot beach club & marina. Very exciting!”

Owner: M/Y Ocean Club 50m

C-Dock

Avoid Lifting

A "garage" at water level

The patent pending docking station compatible with Seabobs is another modular addition to the NautiBuoy inflatable range.

The C-Dock offers you peace of mind, providing your Seabob with a convenient method of protection, from yachts, jet-skis and other watersports equipment. With buckle and webbing security straps. It's not going anywhere.

Solo or Multiple

The flexibility to choose

Available in 2 different options the C-Dock offers versatility due to it's solo & modular nature.

With options to anchor, tether, be connected to other C-Docks or to NautiBuoy platforms the choice & flexibility is yours.



C-Dock Sport

The Sports C-Dock offers a unique "RIB collar" style solution, that is even more lightweight, stowable and quick to inflate.

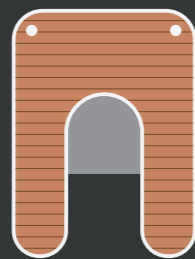

C-Dock Voyager

With a luxurious teak foam finish and drop stitch core this version has been designed with the same key features as the Sports Series.

Compatible with all sizes in the NautiBuoy platform range the Voyager C-Dock offers a smooth continuation of the NautiBuoy platform lines.

The drive-in, drive-out solution

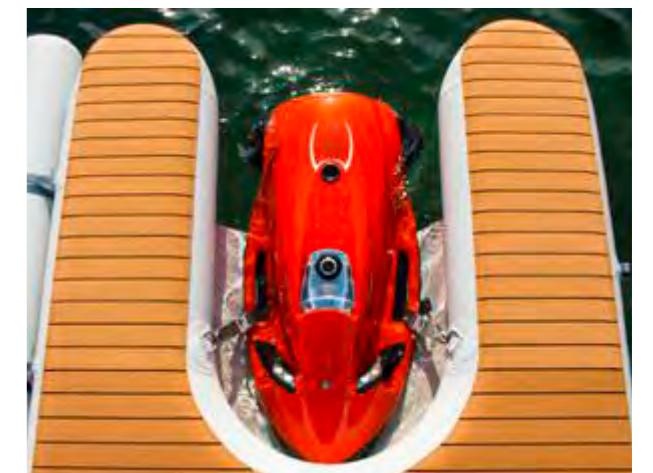

"Stable, high quality, easy to use. The perfect complement to your SEABOB"

Claus Gruner. CEO SEABOB U.S.A

Compatible with F5, F5S & F5SR Seabob models

Sport Series

The Streamlined Platform

Add valuable deck space

The Sport Series platforms are a fantastic solution to providing extra, valuable outside space to yachts of all sizes.

They have been simplified and stripped back to create a streamlined, more cost effective alternative to the Voyager. They have all of the key features provided on the Voyager series, except they are only capable of end-to-end linking.

Ideal for streaming off the back of a vessel or simply anchoring off ones favourite beach. The Sport Series Platforms are essential for yachts looking for more relaxation area.

These can still be used with all of the leisure and maintenance accessories.



Voyager Series

Endless possibilities

Secure & simple connections

One of the key features of our platforms is the Air Toggle System, which as well as allowing them to be linked in multiple configurations*, also provides a 2nd air chamber for safety.



Configurations

The freedom to choose

The revolutionary patent pending Air Toggle linking system is unique to NautiBuoy Marine. Quick and easy to inflate, you can change configurations with very little time and effort.

Cleverly designed, the system enables you to link all four platform sizes to one another to create

anything from jet-ski docks to longer pontoons and shapes that allow access to any part of your yacht.

The Voyager series enables all linking configurations. The Sports series end-to-end only.

Also, if you have a Seabob you can now add the new C-Dock to your chosen configuration (page 24).

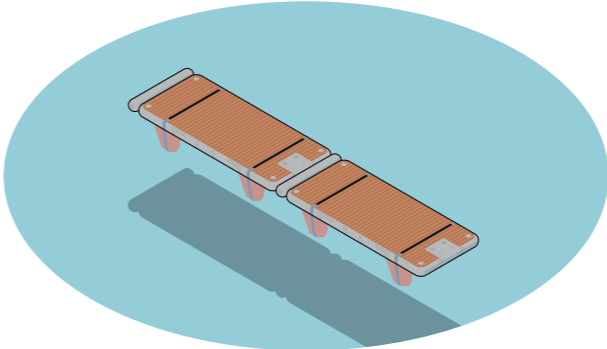

End-to-end linking

Allows for longer maintenance platforms, walkways and pontoons

Voyager & Sport

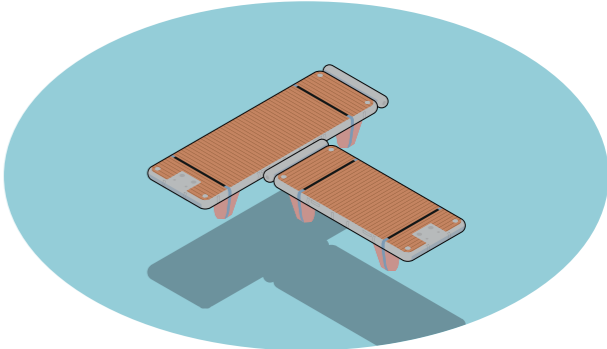

Jet-ski dock (T-shape)

Makes an ideal jet-ski dock

Voyager, with option to use a Sport as the finger pontoon

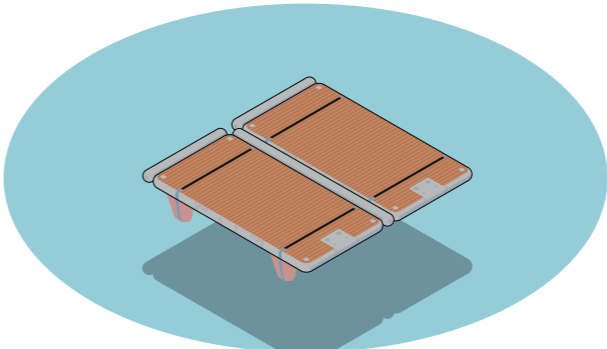

Side-by-side linking

Creates a wider space for your own private dock or dinner party

Voyager only

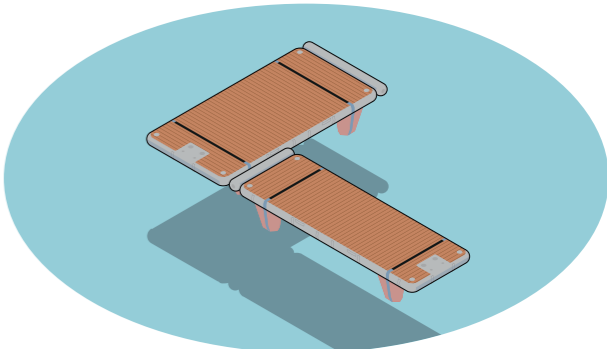

L-shape linking

Makes a great drop off point for guests in a tender

Voyager, with option to use a Sport as the finger pontoon



Jet-ski dock

Soft landings

By simply connecting any two platforms in a T-shape, you're able to configure your own jet-ski dock. This limits any damage to transoms and jet-skis, as well as providing a safer, easier transfer for yourself and your guests.

“The NautiBuoy concept has proved to be a huge success on board. The versatility and sturdiness of the platforms allows us to offer our guests an extremely safe and comfortable environment to enhance their water-side experience.

The lightweight construction of the platforms means we can save valuable time when deploying or recovering our swim-platform set-up, keeping guests and crew happy all day long.

Highly recommended.”

Captain Steve Osborne MY Slip Stream



How Air Toggles work

Versatile, simple and easy to use

All of our platforms have strategically positioned soft loop vertical handles. Simply undo the Velcro to release the Air Toggle loops for your desired configuration. The platforms can then be pulled together (fig. 1) and linked securely.

By inserting the deflated Air Toggle through all the loops and inflating, you are able to create an instant entrapment free connection (fig. 2). To add extra security when linking platforms connection straps are provided.

When linking platforms side by side, longer toggles are required.*

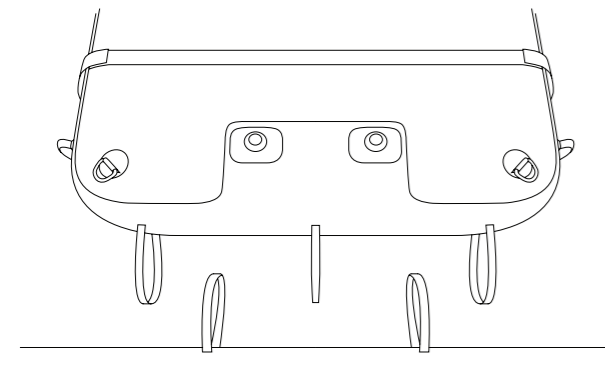

Fig. 1

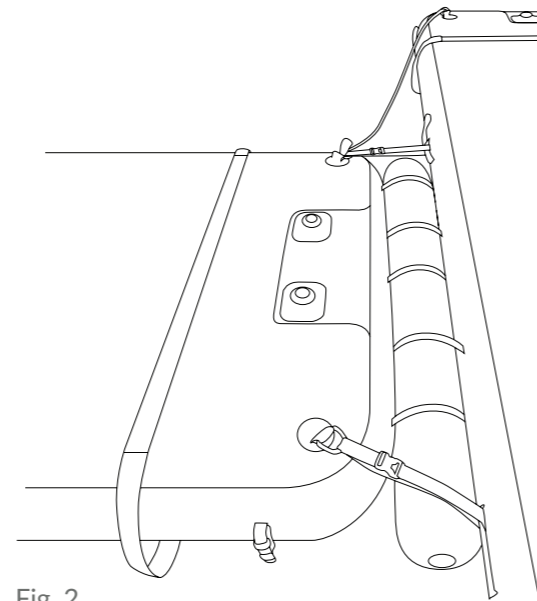

Fig. 2

Safety

The entrapment free connection

Not only does the Air Toggle System add flexibility with connection, it also provides our platforms with a 2nd air chamber for safety, meeting strict EN 15649-1-2-3:2012 compliance regulations.

Designed to stop the platforms rising and falling on top of each other in swell, they also prevent possible entrapment between connected platforms. The Air Toggle system keeps the platforms level with each other during any movement.

The right platform for you

Three simple steps

Choose your series, size, surface and then accessories

With a vast range of platforms to choose from, we have found the following flow of choice works well in establishing the perfect platform/s for your unique requirements.

First choose the series of Platform you require, Sport or Voyager, then the size or sizes that suit your vessel, followed by the surface you prefer then finally any accessories you wish to enhance your experience.

NautiBuoy's CAD team are also on hand if you require drawings for your particular vessel's requirements.

Choose your:

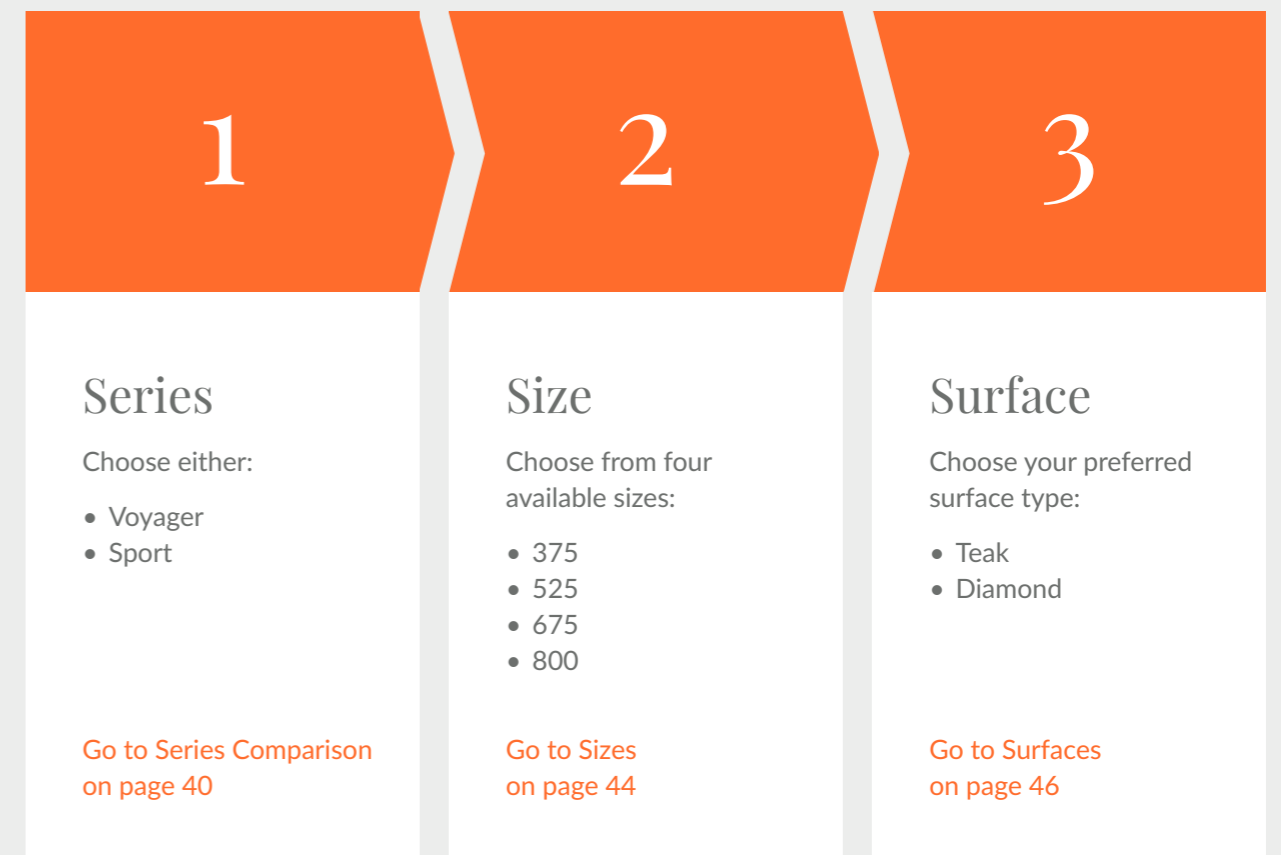

1. Choose your series



SPORT

End-to-end linking only

Designed as a cost effective alternative to the Voyager, the Sports Series has all the key features of the Voyager Series other than the endless linking possibilities.

With Air Toggle linking just on their ends, they are great to create solo swim platform extensions, private islands & walkways. They

can also be used connected to a Voyager as the finger pontoon of a jet-ski dock.

The Sport Series with Diamond surface makes an excellent maintenance raft.

C-Docks can be attached on to the platform ends only.

Linking options

Sport Series can link to **either end only**.

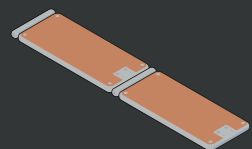

End-to-end

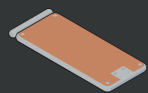

Sport series makes a perfect solo platform.

VOYAGER

Endless linking

The beauty of the Voyager Series is their endless linking capabilities, allowing you to create the perfect shape and size of extension to suit your yacht.

With options to create large traditional beach clubs, jet-ski pontoons, Seabob docking stations,

walkways, diving platforms, private islands or almost any other use you can think of.

Plus you have the flexibility to link the C-Docks to all sides of the Platforms

Linking options

Voyager Series can link on **all four sides**.

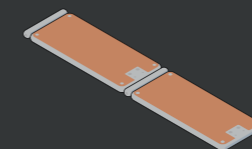

End-to-end

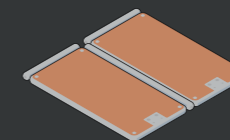

Side-by-side

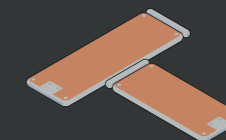

Jet-ski dock (T-shape)

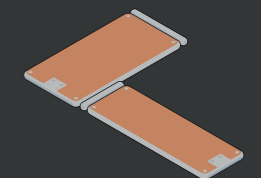

L-shape linking

What will you build?

Popular configurations

With our modular design all of our products work with one another allowing you to build exactly what you need. The diagrams on this page represent a small proportion of what you

could do, but also give you insight into how each of the Series can work with one another. The Voyager series can link on all 4 sizes and the Sport series can link onto it's ends only.

Guide to platforms required:



Voyager Series only

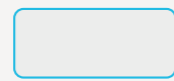

Sport or Voyager Series can be used

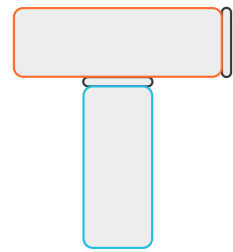

Jet-ski dock
(T-shape)

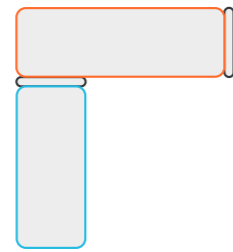

Watersports station
(L-shape)

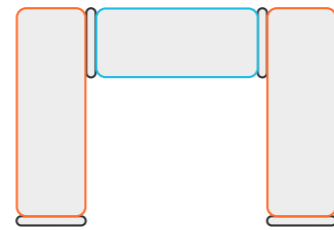

Watersports station
(U-shape)

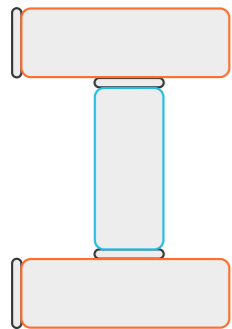

Jet-ski dock & beach club
(H-shape)

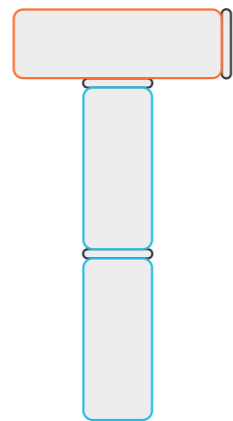

Jet-ski dock
(T-shape)

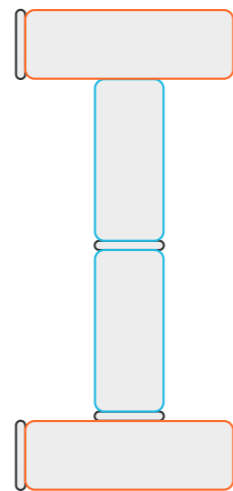

Jet-ski dock & beach club
(H-shape)



Walkway to aqua park



Walkway to aqua park

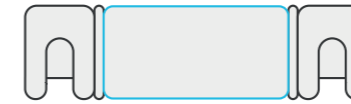

Seabob docking station

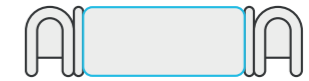

Seabob docking station

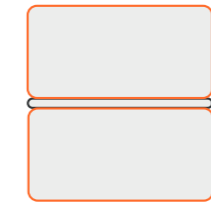

Side-to-side

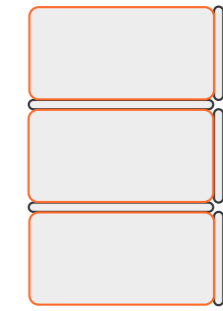

Beach club

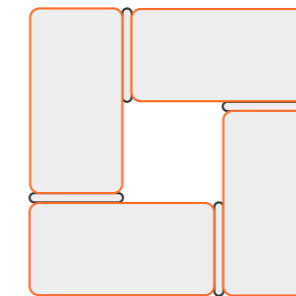

Beach club
(O-shape)

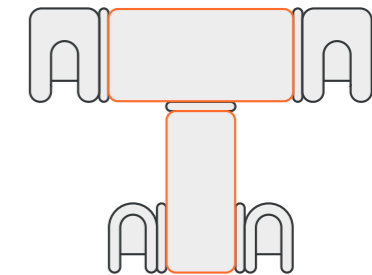

Watersports station
(T-shape)

When linking multiple platforms, of 3 or more, it is advised to consult with NautiBuoy's team of experts. They are on hand to help design the perfect, safest fit for your unique requirements.

2. Choose your size

Platform sizes

Which size suits you?

All our platforms are made from 200mm (7.5") deep dropstitch, pack down to a conveniently stowable size and with 4 different sizes, there is a platform to fit every yacht.

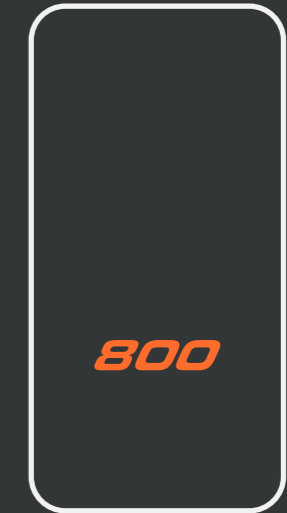
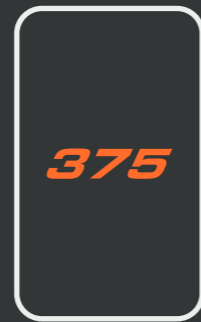

	375	525	675	800
Dimensions	2.5m x 1.5m (8'2" x 4'11")	3.5m x 1.5m (11'5.5" x 4'11")	4.5m x 1.5m (14'9" x 4'11")	4m x 2m (13'1.5" x 6'6")
Stowage dimensions	160cm x 30cm x 30cm (5'3" x 1' x 1')	160cm x 33cm x 33cm (5'3" x 1'1" x 1'1")	165cm x 38cm x 38cm (5'5" x 1'3" x 1'3")	220cm x 32cm x 32cm (7'3" x 1'11" x 1'11")
Inflation/deflation time (250mb/3.6psi)	1m 30 secs	1m 40 secs	2m 40 secs	3m 30 secs
Max users				
Max load	410kg (903 lbs)	480kg (1058 lbs)	600kg (1322 lbs)	700kg (1543 lbs)
Weight out of bag	22kg (48lbs)	29.5kg (48lbs)	33.5kg (73lbs)	39.5kg (87lbs)
Weight in bag	24kg (52lbs)	31.5kg (69lbs)	35kg (78lbs)	42.5kg (94lbs)

All dimensions, weights and times indicated have a tolerance of plus or minus 5%.
All weights and dimensions indicate Sports Series platforms.

3. Choose your surface



Teak

- More traditional look
- Teak effect PE foam
- Looks and feels great
- Soft underfoot & comfortable on the skin
- Repels water
- Easy to wash out stains (tested with suntan cream SPF50, coffee, red wine & cola)
- Non- Skid
- UV resistant – tested to 3000 hours
- Heat resistant up to 110° Celsius / 230° Fahrenheit
- Rolls up and stows easily on and under rib-collars, or in sail lockers & lazarettes



Diamond

- Contemporary look for the more modern yacht.
- Non- skid German PVC
- Easy to clean
- More cost effective than Teak
- Easy to convert into a maintenance platform
- Robust, durable & hard wearing
- Light grey finish repels heat
- Has the flexibility to be folded as well as rolled so they can fit into various shaped storage spaces

Accessories

Which accessories do you require?

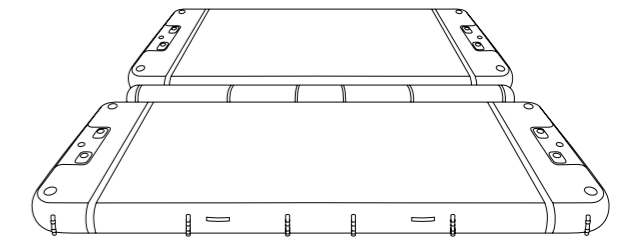

Classic Leisure Pack

The classic leisure pack is ideally suited to the smaller yacht limited on storage space.

The classic comfort seats stow flat at 145cm x 48cm x 8cm / 4'9" x 1'7" x 3".

Each pack comprises two portable classic comfort seats, two fastening belts & two luxury headrests.

Luxury Leisure Pack

The ultimate in comfort, the luxury comfort seats are longer, wider & thicker measuring 195cm x 58cm x 10cm/ 6'5" x 1'11" x 4" when stowed flat.

Each pack comprises two portable luxury comfort seats, two fastening belts & two luxury headrests.

Boarding Ladder

Made from 316 marine grade stainless, this user friendly 4-step boarding ladder makes it safe & simple to get back on to the platform.

Side Joining Air Toggles

When linking side-by-side use one Air Toggle only for an entrapment free connection.

These can be purchased separately for the entire length of your Platform size.



Maintenance Pack

Designed to convert the Teak platforms from a guest leisure platform to a fully equipped crew maintenance raft.

Available in 4 different sizes, each pack comes with a protective non-skid maintenance cover, two Velcro bottomed 37 litre collapsible buckets & four hose holders.

For those messier paint jobs the Diamond Platforms can also be converted with the use of the cover.

Maintenance Add-on

Without the use of the cover, the Diamond Maintenance add-on quickly converts any Diamond Platform into a light work raft.

Each pack comes with two Velcro bottomed 37 litre collapsible buckets, four hose holders, two Suction cups with cleats and two 8m (26') 14mm (0.5") eye spliced polyester dock lines.

L-Bows

For transoms that are higher than the platforms off the water line, 20cm/7.5", a pair of L-Bows can be the solution. Designed to create extra height the L-Bows add an extra 55cm (21.5") in height to the platform and are suitable for transoms up to 0.45m (1'6").

C-Dock

Docking station for Seabobs

Available in two different options Sport or Voyager, the C-Dock offers versatility. With options to anchor, tether, connect to other C-Docks or to NautiBuoy platforms.

Sport - Offers a unique "RIB Collar" style solution that is even more lightweight, stowable and quick to inflate

Voyager - Compatible with all sizes in the NautiBuoy Platform range the Voyager C-Dock offers a smooth continuation of the NautiBuoy platform lines.

Accessory pack contents



Accessory Pack

Supplied with every order of Sport & Voyager series

1. Stowable zipless protective bag (x 1)
2. Air Toggle (x 1)
3. Bravo SUP stirrup pump* (x 1)
4. Repair kit with instructions (x 1)
5. Bravo Electric Pump* (230v or 120v) (x1)
6. Instruction manual (x 1)
7. Connection straps (x 2)

*Bravo SUP pump and Bravo Electric Pump may vary from the picture shown.

Platforms in the stern



L-Bows

Prevent them from drifting under your transom

We recognise that transoms vary in height and design and that platforms have the potential to occasionally drift underneath the stern, particularly when being used as a jet-ski dock.

For transoms that are higher than the platforms off the water line, 20cm/7.5", a pair of L-Bows can be the solution. Designed to create extra height the L-Bows add an extra 55cm (21.5") in height to the platform and are suitable for transoms up to 0.45m (1'6") off the water line.

Simply feed through the Air Toggle loops at either end or side of the platform and inflate. The L shape of the pair of inflated tubes sits against the transom, acting as a buffer.

Available in 2 different sizes:

- 1.5m long x 75cm upright (4'9" x 2'4")
- 2m long x 75cm upright (6'5" x 2'4")

Visit our website to view the L-Bows in use.

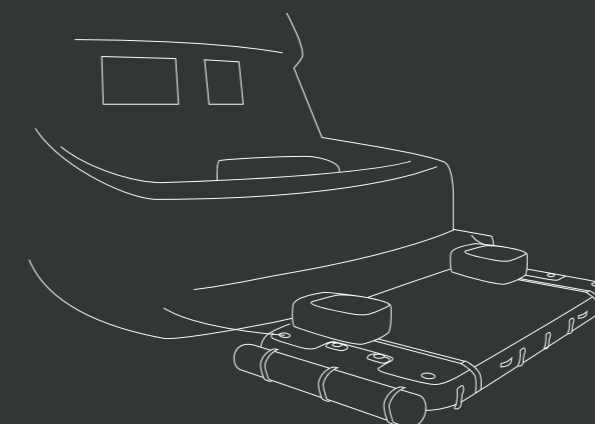

Transom Bumpers

The inflatable transom bumpers can be effortlessly fastened to the velcro surface of the platform adding another 35cm (1ft) in height. They are suitable for transoms up to 0.45m (1'6") off the water line.



Maintenance

Multi-functionality

Switch easily from guest to crew use

In the relentless pursuit for the perfect solution, we've designed our platforms to have the ability to transform from a guest ready leisure platform into a solid inflatable maintenance tool. Simply add the lightweight, non-skid fitted cover to protect the platform and your crew can easily clean, varnish, paint, polish and have the hull of the yacht looking immaculate before leaving port.

With the addition of collapsible Velcro bottom buckets and hose holders, your crew can work efficiently around the topsides without losing equipment over the side.



Platform with cover



Yard maintenance

Where's the marina raft?

You'll never have to play "where's the raft?" in a yard period again. There'll always be a solid multi-purpose inflatable raft to work from whenever you need it. Specifically designed with soft loops and edges, it can sit alongside your vessel for days without you having to worry about any damage.

The platforms can be connected end-to-end for those larger yard period topside projects. There's no limit to the length of platform you can create, and with the addition of triangles to create corners, you can work round any bow or stern. The platforms and triangles can be fully protected using the fitted maintenance covers.

Platform shown with cover

A tender free solution

Practical seamanship

The NautiBuoy Marine Platform dramatically simplifies the cleaning and maintenance of superyachts.

The platform can be single-handedly inflated and launched anywhere in less than five minutes, providing instant access to the water line and allowing crew members to work smarter – not harder. Gone are the days of having to detail the tender after a full topside wash down. Our unique ballast bag system provides excellent stability in the water and enables easy removal from the water after use.

Suction cups with cleats are provided†. A simple and convenient tool to attach the platform to the topsides of the boat, they make quick and easy work of manoeuvring your way around the vessel.

Platform shown with cover





Purely Maintenance

Platforms for the professionals

The robust Diamond non-skid finish, is durable yet easy to clean which makes these platforms an ideal tool for carrying out paint and varnish work as well as routine weekly wash downs of the hull and daily generator soot removal.

All the Diamond finish platforms within our range can still be linked end-to-end allowing users to make giant working platforms during yard periods.

They can be converted simply into a maintenance tool with the use of a Maintenance add-on.

- Tender Free Solution – eliminates the need to detail the tender, again
- No more searching – a platform on hand at all times
- No damage to the vessel and paintwork – can sit alongside for days
- Stable and easy to remove from the water
- Easy to clean
- Hose Holders and Collapsible Buckets with Velcro bottom to prevent loss overboard





Due to design changes and improvements, the products present in the picture may not exactly depict the products purchased by the consumer.

Maintenance Accessories

Dual functionality

Convert to a maintenance raft

Keep the tender guest ready and use the platform as a fantastic tool for carrying out all topside maintenance instead. As well as being quick to inflate, it's amazingly simple to convert from a guest leisure platform to a fully equipped crew maintenance raft.

Maintenance add-on

Convert the Diamond Platforms

Without the use of the cover, the Diamond Maintenance add-on quickly converts any Diamond Platform into a light work raft. Each pack comes with two Velcro bottomed 37 litre/9.77 gallon collapsible buckets, four hose holders, 2 x Suction cups with cleats and 2 x 8m (26ft), 14mm (0.5") eye spliced polyester dock lines.

For those messier paint jobs the Diamond Platforms can still be converted using the Maintenance Pack with the cover.



Maintenance pack

Convert the Teak platforms

Each pack comes with a protective non-skid maintenance cover, two Velcro bottomed 37 litre/9.77 gallon buckets, four hose holders, 2 x suction cups with cleats and 2 x 8m (26ft), 14mm (0.5") eye spliced polyester dock lines.





Platform with cover (cover only included in Maintenance Pack)

Fully protective fitted cover

Non-skid, durable, marine grade construction

Designed to fully protect the platform during all painting, varnishing and washdowns, the cover is user friendly, easy to clean and quick to stow.

The top surface is diamond non-skid for resilience and safety and has two Velcro strips stitched at either end for accessory attachment. The borders are made from high strength, abrasion, mildew and resistant fabric and are designed to fit snugly to the platform. It's been purposefully designed in a light reflective colour to prevent getting hot underfoot. Full access is still available to the valves, MPM's and end Air Toggle loops.

The design of the cover still allows for the connection of platforms end-to-end for those big yard maintenance projects. A connection cover is also available to provide protection to the Air Toggle.



Collapsible buckets with lids

Simplifies maintenance

Our unique expandable 37 litre/9.77 gallon buckets are not only fantastic for wash downs but also for the storage of paints, varnishes and work tools.

A conveniently portable storage container that packs flat and would be of benefit in any bosun's locker. The Velcro strip on the bottom ensures secure fastening to the platform.

Conveniently sold in pairs so you have one bucket for your soapy water and a storage container for spares.



Hose holders

Put an end to hose loss

You can now work quickly and efficiently around the vessel without playing tug of war with the hose, keeping it exactly where you need for a trouble free wash down. Two hose holders easily attach to the platform MPM's and hold it in position, whilst you focus on the job in hand. Get those top sides finished in record time.



Platform with cover

Design

Designed for yachtsmen by yachtsmen

It's all in the details



British design
British designed by ex-superyacht crew with 25 years experience. We have European design protection and 12 patents pending.



Handmade in Europe
The platforms are meticulously hand crafted and made to our exacting specifications by leading industry professionals.



Durability
The Platforms are constructed from a dropstitch core, with borders made from Mehler German PVC which is known for its strength and durability.



Non-skid surface
Both of our surface finishes Teak or Diamond provide a non-skid surface for safety.



Diamond finish
Our Diamond non-skid PVC surface provides a robust easy to clean finish with a contemporary look.

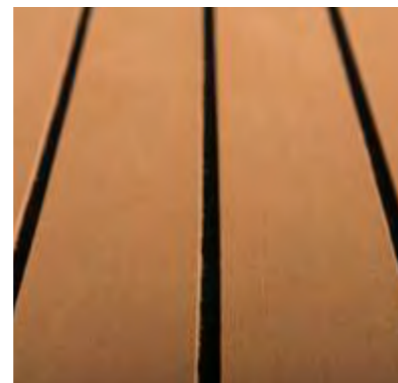

Teak finish
Our UV resistant teak look surface is not only soft under foot and comfortable on the skin, it also provides a non-skid floor for safety. Patent Pending.

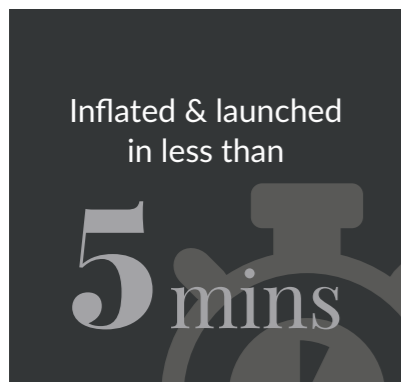

Quick to inflate
Quick and easy to inflate and deflate to 3.6 psi / 250mb. Inflation/deflation times range from approximately 1min 30sec to 3mins 30 secs depending on platform size.

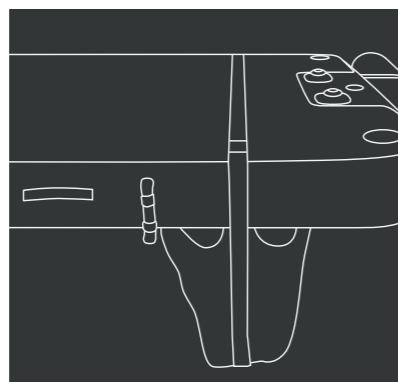

Ballast system
Wave laboratory tested and refined to give superior stability on the water.

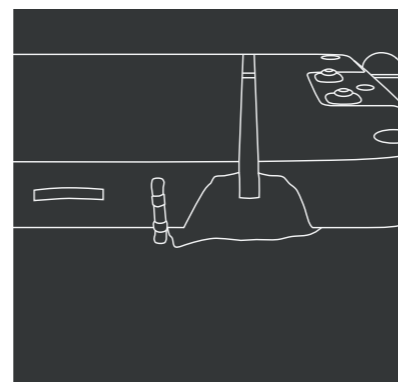

Ballast dump system
The patent pending ballast dump system expels all the ballast water from each bag in one simple, easy movement.



Rigid
Extremely rigid & stable once inflated due to its dropstitch core and ballast system.



Easy to Stow
We understand the value of storage space on your yacht. Our platforms can be deflated and rolled into a conveniently stowable protective bag with large internal pockets.



Easy to remove from the water
After the ballast water has been expelled, platforms are lightweight to remove from the water.



Air Toggle loops
The Air Toggle loops have an easy tidy-away Velcro system for when not in use. Quick to release and rapid to secure, they keep the platform looking streamlined.



Soft loops
Only soft loops are used on the bottom and edges of the platform to prevent any damage to the topsides, paint and varnish work, as well as the teak deck.



Lifting handles/connection points
The Voyager series platform has 4 lifting handles strategically positioned for dual use. They provide lifting points and are used when linking platforms together.



Stainless steel D-rings
Heavy duty 316 Stainless D-rings designed with extra large bonded pads, ideal for tying the platform to the vessel or attaching jet-skis and watersports toys to the platform.



Glued & stitched
Teak effect foam stitched and glued for extra reinforcement



Connection straps
Made from high strength UV resistant webbing with long-lasting corrosion free buckles, these add extra security when linking platforms using the Air Toggle System.



Multipurpose Platform Mountings

The Multipurpose platform mountings (MPM's) offer the ability to lock and secure a multiple range of accessories including boarding ladders and hose holders.



Valve

Bravo C7 Halkey Roberts inflation valve with internal protective mesh and an easy push release button. The fitting allows for the OV10 pump to be secured into the valve for hands free inflation and deflation.



Pressure release valve

All our platforms and Air Toggles are fitted with Leaffield Marine A6 5.5psi/ 379mb pressure release valves. These ensure the release of excess pressure due to the expansion of air in hot temperatures.



Anchor point

Doubled over Dyneema loops secured with 3 layers of seatbelt webbing in a fan shape, bonded and stitched onto an extra large pad for safety and security. Designed for mooring, anchoring and towing.



Seatbelt webbing

For all handles, D-rings and anchor points, industrial 50mm seat belt webbing has been used. The lifesaving technology offers reliable strength and longevity.



Extra reinforcement

We've added a double layer of material to protect against wear and tear from the ladder

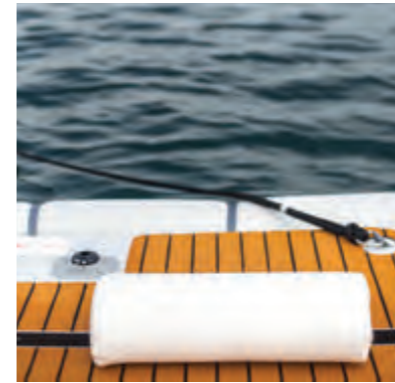

Secure accessories

To prevent loss of accessories overboard, 50mm strips of Velcro have been stitched to both the top of the platform and the maintenance cover.



Suction cups with cleats[‡]

A simple and convenient tool to attach the platform to the topsides, making quick, easy work of manoeuvring around the vessel. (Provided with the Maintenance Packs only)



Docklines[‡]

Black 8m (26ft), 14mm (0.5") eye spliced polyester docklines are provided for securing platforms alongside or behind any vessel. (Provided with the Maintenance Packs only)



Bravo manual stirrup pump with pressure gauge[‡]

Provided for the inflation of the Air Toggle whilst the users are on the water and also to top up the pressure of the platforms. The pump also allows the monitoring of pressure



Bravo OV10 pump

A compact fast inflating/deflating electric pump with Halkey Roberts connection nozzle. Options are available for 230v and 120v. Maximum inflation 3.6psi/250mb.



Conveniently stowable

All our platforms role up and fit comfortably into our ziiless protective bags, which can be stowed under rib collars, in lazarettes or most work lockers.

[‡]Bravo SUP pump and Bravo Electric Pump may vary from the picture shown.



Materials

Voyager & Sport

Made from 200mm PVC dropstitch with Mehler German PVC borders and ballast bags. Mehler known for their superior quality PVC, offers a trusted solution.



-  Ultraviolet light resistance
-  Weather resistant
-  High & low temperature resistant
-  Easy to clean
-  Wearproof surface

Maintaining shape

The dropstitch can be inflated to high pressures whilst maintaining its shape due to the thousands of polyester threads between two layers of fabric. Once inflated to 5.5 psi (379 mb), it creates an incredibly solid base and with the addition of four ballast bags provides you with a strong, stable, floating platform.



Compliance

15649 - 1-2-3 : 2012 Compliant

For your safety the platforms have been rigorously tested to meet strict European regulations (EN) for floating leisure articles for use on the water.

The product has been put through its paces in test houses, wave pools, and on charter and private yachts as prototypes. Through this process design features have been changed and refined, ensuring that you have safe platforms that meet European guidelines.



Specifications

METRIC - SPECIFICATIONS TABLE

Platform name	Max. no of users	Inflated dimensions (all 20cm deep)	Approximate inflation/deflation time to 250mb	Stowage dimensions (metric)	Weight out of bag (kg)	Weight in bag (kg)	Max load (kgs)
375	3	2.5m x 1.5m	1m 30 secs	160cm x 30cm x 30cm	22	24	410
525	4	3.5m x 1.5m	1m 40 secs	160cm x 33cm x 33cm	29.5	31.5	480
675	5	4.5m x 1.5m	2m 40 secs	165cm x 38cm x 38cm	33.5	35	600
800	5	4m x 2m	3m 30 secs	220cm x 32cm x 32cm	39.5	42.5	700

IMPERIAL - SPECIFICATIONS TABLE

Platform name	Max. no of users	Inflated dimensions (all 7.5" deep)	Approximate inflation/deflation time to 3.6psi	Stowage dimensions (imperial)	Weight out of bag (lbs)	Weight in bag (lbs)	Max load (lbs)
375	3	8'2" x 4'11"	1m 30 secs	5'3" x 1' x 1'	48	52	903
525	4	11'5.5" x 4'11"	1m 40 secs	5'3" x 1'1" x 1'1"	48	69	1058
675	5	14'9" x 4'11"	2m 40 secs	5'5" x 1'3" x 1'3"	73	78	1322
800	5	13'1.5" x 6'6"	3m 30 secs	7'3" x 1'11" x 1'11"	87	94	1543

Useful pages

Added space	Page 24
Platform types overview	Page 38
Popular configurations	Page 42
Platform sizes	Page 44
Platform surface types	Page 46
Accessories	Page 48

All dimensions, weights and times indicated have a tolerance of plus or minus 5%.

Due to design changes and improvements, the Platforms present in the pictures may not exactly depict the product purchased by the consumer.



The Foundation of NautiBuoy

Both founders and directors of NautiBuoy have backgrounds in the Superyacht industry.

Nina Anderson started work as stewardess on large Motor yachts in the Mediterranean as well as in Mexico and the US. She was quickly promoted and soon became Chief Stewardess. In this role she naturally picked up a keen eye for guest welfare as well as perfect attention to detail. With her unique style, she has created the ultimate range of platform leisure accessories.

Clay Builder was brought up sailing in Mallorca on his fathers yacht and windsurfing school. At 18, he completed a years mariner graduate programme. After 5 years as a yacht trainer and running flotillas in Europe, he began an 11 year career on several large sail and motor yachts as Bosun, Mate and eventually Officer.

After 100s of wash downs using guest ready tenders and even more hours repairing jet ski's and damage caused to transoms, as well as frustrating days spent looking for marina rafts, Clay realised the need for a multi-functional inflatable platform that yachts could always have access to and easily stow on board.

They both also saw the need for a stable leisure platform where guests could relax, close to the water on a floating island of comfort, or dock their jet-skis safely whilst enjoying the water sports on the yacht.

Their aim was to produce a premium quality platform of superior durability and multi-functionality. Whilst working together on a Med based motor yacht, NautiBuoy was born.

* Voyager series only
 † Excludes Sport series
 ‡ Not included with Sport series

Designed by Jenerator Ltd & Studio in the Sticks.
 Location photography by Boris Austin, Jim Raycroft & Bernard Bonomo.
 Studio photography by Rifle Design & The Really Good Media Company.

Designed and printed in the UK. NautiBuoy Marine™ is a registered trademark of NautiBuoy Marine Ltd. The Platform is a registered European Design. Patent Pending. Terms of business are available upon request. The details herein are believed to be correct but buyers should make further enquiries regarding their accuracy before relying on the information herein to form part of a contract.

© Copyright NautiBuoy Marine Ltd 2015 - 2018. Registered in England no: 8384675.



www.nautibuoymarine.com

t: +44 (0) 1364 643921 e: info@nautibuoymarine.com

